

### FEATURES

RoHS compliant, 16-lead, wide body SOIC package

Low power operation: 5 V

1.3 mA per channel maximum @ 0 Mbps to 2 Mbps

3.3 mA per channel maximum @ 10 Mbps

High temperature operation: 105°C

Up to 10 Mbps data rate (NRZ)

Low default output state

Safety and regulatory approvals

UL recognition: 2500 V rms for 1 minute per UL 1577

### APPLICATIONS

General-purpose, unidirectional, multichannel isolation

### GENERAL DESCRIPTION

The ADuM1510<sup>1</sup> is a unidirectional, 5-channel isolator based on the Analog Devices, Inc., *iCoupler*® technology. Combining high speed CMOS and monolithic air core transformer technology, these isolation components provide outstanding performance characteristics superior to alternatives such as optocoupler devices.

By avoiding the use of LEDs and photodiodes, *iCoupler* devices eliminate the design difficulties commonly associated with optocouplers. The typical optocoupler concerns regarding uncertain current transfer ratios, nonlinear transfer functions, and temperature and lifetime effects are eliminated with the simple *iCoupler* digital interfaces and stable performance characteristics. The need for external drivers and other discrete components is eliminated with *iCoupler* products. In addition, *iCoupler* devices run at one-tenth to one-sixth the power consumption of optocouplers at comparable signal data rates.

The ADuM1510 isolator provides five independent isolation channels supporting data rates up to 10 Mbps. The ADuM1510 operates with the supply voltage of either side ranging from 4.5 V to 5.5 V. Unlike other optocoupler alternatives, the ADuM1510 isolator has a patented refresh feature that ensures dc correctness in the absence of input logic transitions and during power-up/power-down conditions.

<sup>1</sup> Protected by U.S. Patents 5,952,849, 6,873,065, and 7,075,329. Other patents pending.

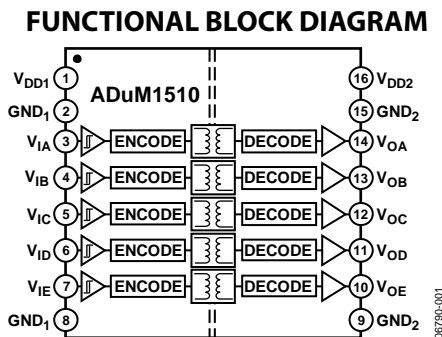

### Rev. A

Information furnished by Analog Devices is believed to be accurate and reliable. However, no responsibility is assumed by Analog Devices for its use, nor for any infringements of patents or other rights of third parties that may result from its use. Specifications subject to change without notice. No license is granted by implication or otherwise under any patent or patent rights of Analog Devices. Trademarks and registered trademarks are the property of their respective owners.

## TABLE OF CONTENTS

Features .....	1	ESD Caution.....	5
Applications.....	1	Pin Configuration and Function Descriptions.....	6
General Description .....	1	Typical Performance Characteristics .....	7
Functional Block Diagram .....	1	Applications Information .....	8
Revision History .....	2	PCB Layout .....	8
Specifications.....	3	Propagation Delay-Related Parameters.....	8
Electrical Characteristics—5 V Operation.....	3	DC Correctness and Magnetic Field Immunity.....	8
Package Characteristics .....	4	Power Consumption .....	9
Regulatory Information.....	4	Power-Up/Power-Down Considerations .....	9
Insulation and Safety-Related Specifications.....	4	Outline Dimensions .....	11
Recommended Operating Conditions .....	4	Ordering Guide .....	11
Absolute Maximum Ratings.....	5		

## REVISION HISTORY

9/08—Rev. Sp0 to Rev. A

6/07—Revision Sp0: Initial Version

## SPECIFICATIONS

### ELECTRICAL CHARACTERISTICS—5 V OPERATION

All voltages are relative to their respective ground.  $4.5\text{ V} \leq V_{DD1} \leq 5.5\text{ V}$ ,  $4.5\text{ V} \leq V_{DD2} \leq 5.5\text{ V}$ ; all minimum/maximum specifications apply over the entire recommended operation range, unless otherwise noted; all typical specifications are at  $T_A = 25^\circ\text{C}$ ,  $V_{DD1} = V_{DD2} = 5\text{ V}$ .

Table 1.

Parameter	Symbol	Min	Typ	Max	Unit	Test Conditions
DC SPECIFICATIONS						
Input Quiescent Supply Current per Channel	$I_{DDI(Q)}$		0.40	0.80	mA	
Output Quiescent Supply Current per Channel	$I_{DDO(Q)}$		0.30	0.50	mA	
Total Supply Current, Five Channels <sup>1</sup>						
$V_{DD1}$ Supply Current, Quiescent	$I_{DD1(Q)}$		2.0	4.0	mA	$V_{IA} = V_{IB} = V_{IC} = V_{ID} = V_{IE} = 0\text{ V}$
$V_{DD2}$ Supply Current, Quiescent	$I_{DD2(Q)}$		1.5	2.5	mA	$V_{IA} = V_{IB} = V_{IC} = V_{ID} = V_{IE} = 0\text{ V}$
$V_{DD1}$ Supply Current, 10 Mbps Data Rate	$I_{DD1(10)}$		7.5	12.0	mA	5 MHz logic signal frequency
$V_{DD2}$ Supply Current, 10 Mbps Data Rate	$I_{DD2(10)}$		3.1	4.5	mA	5 MHz logic signal frequency
Input Currents	$I_{IA}, I_{IB}, I_{IC}, I_{ID}, I_{IE}$	-10	+1	+10	$\mu\text{A}$	$V_{IA}, V_{IB}, V_{IC}, V_{ID}, V_{IE} \geq 0\text{ V}$
Logic High Input Threshold	$V_{IH}$			2.0	V	
Logic Low Input Threshold	$V_{IL}$	0.8			V	
Logic High Output Voltages	$V_{OAH}, V_{OBH}, V_{OCH}, V_{ODH}, V_{OEH}$	$V_{DD2} - 0.4$	4.8		V	$I_{Ox} = -4\text{ mA}, V_{Ix} = V_{IH}$
Logic Low Output Voltages	$V_{OAL}, V_{OBL}, V_{OCL}, V_{ODL}, V_{OEL}$		0.2	0.4	V	$I_{Ox} = +4\text{ mA}, V_{Ix} = V_{IL}$
SWITCHING SPECIFICATIONS						
Minimum Pulse Width <sup>2</sup>	PW			100	ns	$C_L = 15\text{ pF}$ , CMOS signal levels
Maximum Data Rate <sup>3</sup>		10			Mbps	$C_L = 15\text{ pF}$ , CMOS signal levels
Propagation Delay <sup>4</sup>	$t_{PHL}, t_{PLH}$	20	30	50	ns	$C_L = 15\text{ pF}$ , CMOS signal levels
Pulse Width Distortion, $ t_{PLH} - t_{PHL} $ <sup>4</sup>	PWD			5	ns	$C_L = 15\text{ pF}$ , CMOS signal levels
Change vs. Temperature			5		ps/ $^\circ\text{C}$	$C_L = 15\text{ pF}$ , CMOS signal levels
Propagation Delay Skew <sup>5</sup>	$t_{PSK}$			30	ns	$C_L = 15\text{ pF}$ , CMOS signal levels
Channel-to-Channel Matching <sup>6</sup>	$t_{PSKCD}$			5	ns	$C_L = 15\text{ pF}$ , CMOS signal levels
Output Rise/Fall Time (10% to 90%)	$t_R/t_F$		2.5		ns	$C_L = 15\text{ pF}$ , CMOS signal levels
Common-Mode Transient Immunity at Logic High Output <sup>7</sup>	$ CM_H $	25	35		kV/ $\mu\text{s}$	$V_{Ix} = V_{DD1}/V_{DD2}, V_{CM} = 1000\text{ V}$ , transient magnitude = 800 V
Common-Mode Transient Immunity at Logic Low Output <sup>7</sup>	$ CM_L $	25	35		kV/ $\mu\text{s}$	$V_{Ix} = 0\text{ V}, V_{CM} = 1000\text{ V}$ , transient magnitude = 800 V
Refresh Rate	$f_r$		1.0		Mbps	
Input Dynamic Supply Current per Channel <sup>8</sup>	$I_{DDI(D)}$		0.122		mA/Mbps	
Output Dynamic Supply Current per Channel <sup>8</sup>	$I_{DDO(D)}$		0.036		mA/Mbps	

<sup>1</sup> Supply current values are for all five channels combined running at identical data rates. Output supply current values are specified with no output load present. The supply current associated with an individual channel operating at a given data rate is calculated as described in the Power Consumption section. See Figure 4 through Figure 6 for information on the per-channel supply current as a function of the data rate for unloaded and loaded conditions. See Figure 7 and Figure 8 for total  $I_{DD1}$  and  $I_{DD2}$  supply currents as a function of the data rate for the ADuM1510.

<sup>2</sup> The minimum pulse width is the shortest pulse width at which the specified pulse width distortion is guaranteed. Operation below the minimum pulse width is not recommended.

<sup>3</sup> The maximum data rate is the fastest data rate at which the specified pulse width distortion is guaranteed.

<sup>4</sup>  $t_{PHL}$  propagation delay is measured from the 50% level of the falling edge of the  $V_{ix}$  signal to the 50% level of the falling edge of the  $V_{Ox}$  signal.  $t_{PLH}$  propagation delay is measured from the 50% level of the rising edge of the  $V_{ix}$  signal to the 50% level of the rising edge of the  $V_{Ox}$  signal.

<sup>5</sup>  $t_{PSK}$  is the magnitude of the worst-case difference in  $t_{PHL}$  and/or  $t_{PLH}$  that is measured between units at the same operating temperature, supply voltages, and output load within the recommended operating conditions.

<sup>6</sup> Channel-to-channel matching is the absolute value of the difference in propagation delays between any two channels within the same component.

<sup>7</sup>  $CM_H$  is the maximum common-mode voltage slew rate that can be sustained while maintaining  $V_{Ox} > 0.8 \times V_{DD2}$ .  $CM_L$  is the maximum common-mode voltage slew rate that can be sustained while maintaining  $V_{Ox} < 0.8\text{ V}$ . The common-mode voltage slew rates apply to both rising and falling common-mode voltage edges. The transient magnitude is the range over which the common mode is slewed.

<sup>8</sup> Dynamic supply current is the incremental amount of supply current required for a 1 Mbps increase in the signal data rate. See Figure 4 through Figure 6 for information on the per-channel supply current as a function of the data rate for unloaded and loaded conditions. See the Power Consumption section for guidance on calculating the per-channel supply current for a given data rate.

# ADuM1510

## PACKAGE CHARACTERISTICS

Table 2.

Parameter	Symbol	Min	Typ	Max	Unit	Test Conditions
Resistance (Input-to-Output) <sup>1</sup>	R <sub>I-O</sub>		10 <sup>12</sup>		Ω	f = 1 MHz
Capacitance (Input-to-Output) <sup>2</sup>	C <sub>I-O</sub>		2.2		pF	
Input Capacitance <sup>2</sup>	C <sub>I</sub>		4.0		pF	
IC Junction-to-Case Thermal Resistance, Side 1	θ <sub>JCI</sub>		33		°C/W	Thermocouple located at center of package underside
IC Junction-to-Case Thermal Resistance, Side 2	θ <sub>JCO</sub>		28		°C/W	Thermocouple located at center of package underside

<sup>1</sup> The device is considered a two-terminal device. Pin 1 through Pin 8 are shorted together, and Pin 9 through Pin 16 are shorted together.

<sup>2</sup> Input capacitance is from any input data pin to ground.

## REGULATORY INFORMATION

The ADuM1510 has been approved by the following organization upon product release, as shown in Table 3.

Table 3.

UL
Recognized under UL 1577 Component Recognition Program <sup>1</sup> Double/reinforced insulation, 2500 V rms isolation voltage File E214100

<sup>1</sup> In accordance with UL 1577, each ADuM1510 is proof-tested by applying an insulation test voltage ≥3000 V rms for 1 sec (current leakage detection limit = 5 μA).

## INSULATION AND SAFETY-RELATED SPECIFICATIONS

Table 4.

Parameter	Symbol	Value	Unit	Conditions
Rated Dielectric Insulation Voltage		2500	V rms	1 minute duration
Minimum External Air Gap (Clearance)	L(I01)	7.7 min	mm	Measured from input terminals to output terminals, shortest distance through air
Minimum External Tracking (Creepage)	L(I02)	8.1 min	mm	Measured from input terminals to output terminals, shortest distance path along body
Minimum Internal Gap (Internal Clearance)		0.017 min	mm	Insulation distance through insulation
Tracking Resistance (Comparative Tracking Index)	CTI	>175	V	DIN IEC 112/VDE 0303 Part 1
Isolation Group		IIIa		Material Group (DIN VDE 0110, 1/89, Table 1)
Maximum Working Voltage Compatible with 50 Years Service Life	V <sub>IORM</sub>	565	V peak	Continuous peak voltage across the isolation barrier

## RECOMMENDED OPERATING CONDITIONS

All voltages are relative to their respective ground. See the DC Correctness and Magnetic Field Immunity section for information on immunity to external magnetic fields.

Table 5.

Parameter	Symbol	Min	Typ	Max	Unit
Operating Temperature	T <sub>A</sub>	-40		+105	°C
Supply Voltages	V <sub>DD1</sub> , V <sub>DD2</sub>	4.5		5.5	V
Input Signal Rise and Fall Times				1.0	ms

## ABSOLUTE MAXIMUM RATINGS

Ambient temperature  $T_A = 25^\circ\text{C}$ , unless otherwise noted.

Table 6.

Parameter	Rating
Storage Temperature ( $T_{ST}$ ) Range	$-65^\circ\text{C}$ to $+150^\circ\text{C}$
Ambient Operating Temperature ( $T_A$ ) Range	$-40^\circ\text{C}$ to $+105^\circ\text{C}$
Supply Voltages <sup>1</sup> ( $V_{DD1}$ , $V_{DD2}$ )	$-0.5\text{ V}$ to $+7.0\text{ V}$
Input Voltages <sup>1</sup> ( $V_{IA}$ , $V_{IB}$ , $V_{IC}$ , $V_{ID}$ , $V_{IE}$ )	$-0.5\text{ V}$ to $V_{DDI} + 0.5\text{ V}$
Output Voltages <sup>1</sup> ( $V_{OA}$ , $V_{OB}$ , $V_{OC}$ , $V_{OD}$ , $V_{OE}$ )	$-0.5\text{ V}$ to $V_{DDO} + 0.5\text{ V}$
Average Output Current per Pin <sup>2</sup>	
Side 1 ( $I_{O1}$ )	$-18\text{ mA}$ to $+18\text{ mA}$
Side 2 ( $I_{O2}$ )	$-22\text{ mA}$ to $+22\text{ mA}$
Common-Mode Transients <sup>3</sup>	$-100\text{ kV}/\mu\text{s}$ to $+100\text{ kV}/\mu\text{s}$

<sup>1</sup> All voltages are relative to their respective ground.

<sup>2</sup> See Figure 3 for maximum rated current values for various temperatures.

<sup>3</sup> Refers to common-mode transients across the insulation barrier. Common-mode transients exceeding the absolute maximum ratings may cause latch-up or permanent damage.

Stresses above those listed under Absolute Maximum Ratings may cause permanent damage to the device. This is a stress rating only; functional operation of the device at these or any other conditions above those indicated in the operational section of this specification is not implied. Exposure to absolute maximum rating conditions for extended periods may affect device reliability.

### ESD CAUTION



**ESD (electrostatic discharge) sensitive device.** Charged devices and circuit boards can discharge without detection. Although this product features patented or proprietary protection circuitry, damage may occur on devices subjected to high energy ESD. Therefore, proper ESD precautions should be taken to avoid performance degradation or loss of functionality.

# ADuM1510

## PIN CONFIGURATION AND FUNCTION DESCRIPTIONS

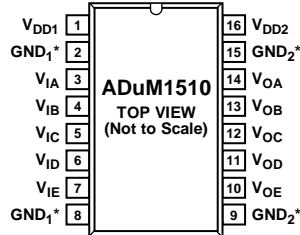

\*PIN 2 AND PIN 8 ARE INTERNALLY CONNECTED. CONNECTING BOTH TO GND<sub>1</sub> IS RECOMMENDED. PIN 9 AND PIN 15 ARE INTERNALLY CONNECTED. CONNECTING BOTH TO GND<sub>2</sub> IS RECOMMENDED.

06790-002

Figure 2. Pin Configuration

Table 7. Pin Function Descriptions

Pin No.	Mnemonic	Description
1	V <sub>DD1</sub>	Supply Voltage for Isolator Side 1 (4.5 V to 5.5 V).
2, 8	GND <sub>1</sub>	Ground 1. Ground reference for Isolator Side 1. Pin 2 and Pin 8 are internally connected, and connecting both to GND <sub>1</sub> is recommended.
3	V <sub>IA</sub>	Logic Input A.
4	V <sub>IB</sub>	Logic Input B.
5	V <sub>IC</sub>	Logic Input C.
6	V <sub>ID</sub>	Logic Input D.
7	V <sub>IE</sub>	Logic Input E.
9, 15	GND <sub>2</sub>	Ground 2. Ground reference for Isolator Side 2. Pin 9 and Pin 15 are internally connected, and connecting both to GND <sub>2</sub> is recommended.
10	V <sub>OE</sub>	Logic Output E.
11	V <sub>OD</sub>	Logic Output D.
12	V <sub>OC</sub>	Logic Output C.
13	V <sub>OB</sub>	Logic Output B.
14	V <sub>OA</sub>	Logic Output A.
16	V <sub>DD2</sub>	Supply Voltage for Isolator Side 2 (4.5 V to 5.5 V).

Table 8. Truth Table (Positive Logic)

V <sub>Ix</sub> Input <sup>1</sup>	V <sub>DD1</sub> State	V <sub>DD2</sub> State	V <sub>Ox</sub> Output <sup>1</sup>	Description
H	Powered	Powered	H	Normal operation, data is high.
L	Powered	Powered	L	Normal operation, data is low.
X	Unpowered	Powered	L	Input unpowered. Outputs return to input state within 1 μs of V <sub>DD1</sub> power restoration. See the Power-Up/Power-Down Considerations section for more details.
X	Powered	Unpowered	Z	Output unpowered. Output pins are in high impedance state. Outputs return to input state within 1 μs of V <sub>DD2</sub> power restoration. See the Power-Up/Power-Down Considerations section for more details.

<sup>1</sup> V<sub>Ix</sub> and V<sub>Ox</sub> refer to the input and output signals of a given channel (A, B, C, D, or E).

# TYPICAL PERFORMANCE CHARACTERISTICS

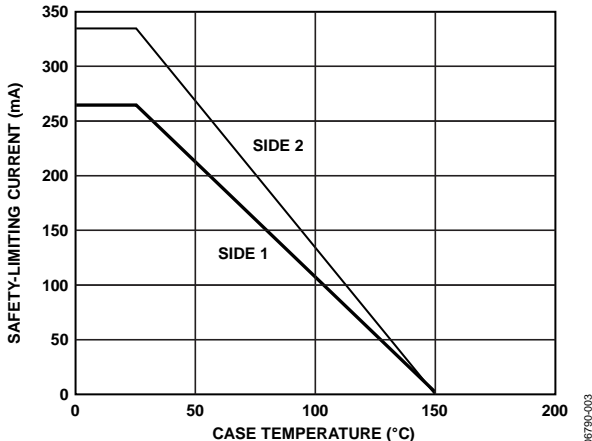

Figure 3. Thermal Derating Curve, Dependence of Safety-Limiting Values with Case Temperature per DIN VVDE V 0884-10

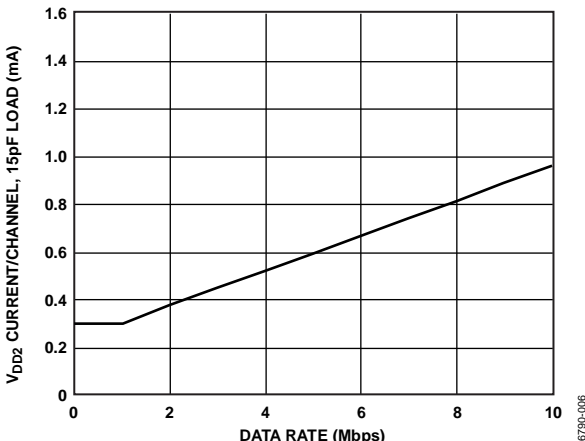

Figure 6. Typical Output Supply Current per Channel vs. Data Rate (15 pF Output Load)

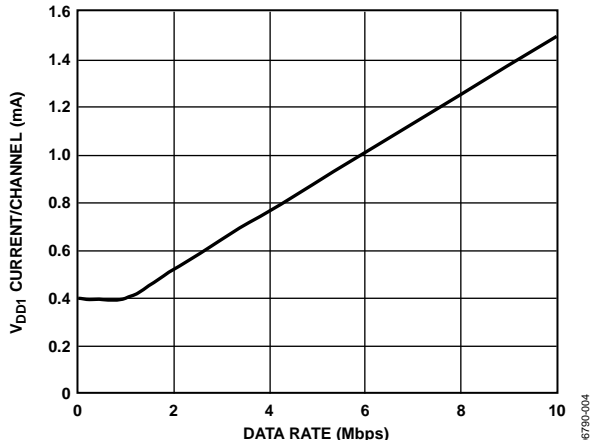

Figure 4. Typical Input Supply Current per Channel vs. Data Rate

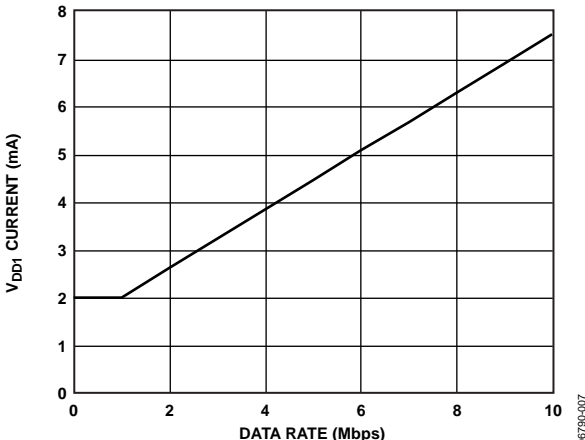

Figure 7. Typical Total V<sub>DD1</sub> Supply Current vs. Data Rate

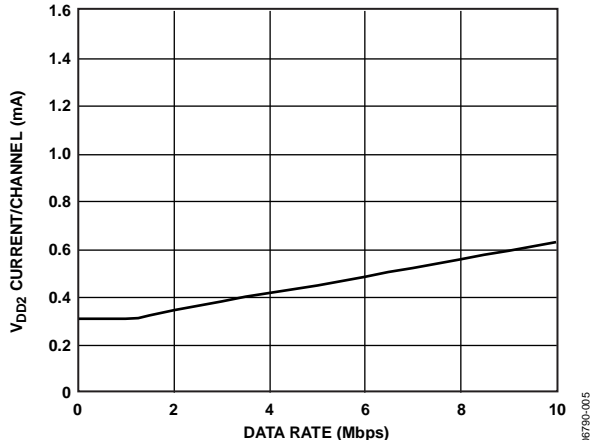

Figure 5. Typical Output Supply Current per Channel vs. Data Rate (No Output Load)

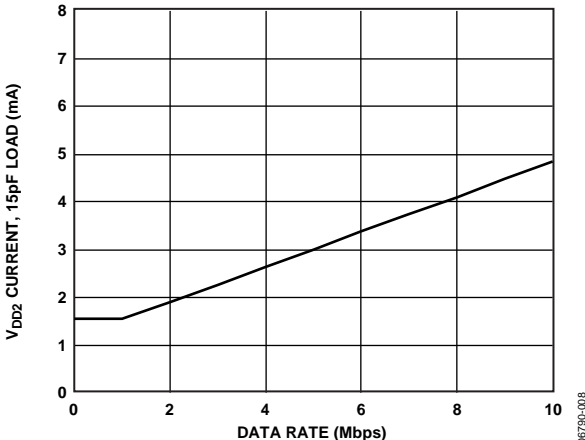

Figure 8. Typical Total V<sub>DD2</sub> Supply Current vs. Data Rate (15 pF Output Loads)

## APPLICATIONS INFORMATION

### PCB LAYOUT

The ADuM1510 digital isolator requires no external interface circuitry for the logic interfaces. Power supply bypassing is strongly recommended at the input and output supply pins (see Figure 9). Bypass capacitors are most conveniently connected between Pin 1 and Pin 2 for  $V_{DD1}$  and between Pin 15 and Pin 16 for  $V_{DD2}$ . The capacitor value should be between 0.01  $\mu\text{F}$  and 0.1  $\mu\text{F}$ . The total lead length between both ends of the capacitor and the input power supply pin must not exceed 10 mm. Bypassing between Pin 1 and Pin 8 and between Pin 9 and Pin 16 should also be considered unless the ground pair on each package side is connected close to the package.

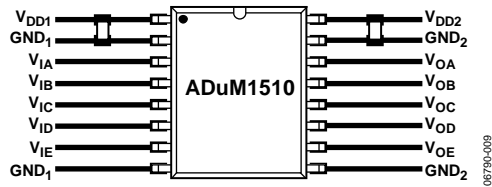

Figure 9. Recommended PCB Layout

### PROPAGATION DELAY-RELATED PARAMETERS

Propagation delay is a parameter that describes the length of time it takes for a logic signal to propagate through a component. The propagation delay to a logic low output can differ from the propagation delay to a logic high output.

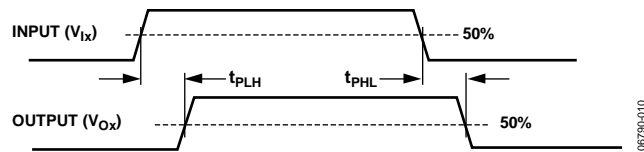

Figure 10. Propagation Delay Parameters

Pulse width distortion is the maximum difference between these two propagation delay values and is an indication of how accurately the timing of the input signal is preserved.

Channel-to-channel matching refers to the maximum amount that the propagation delay differs between channels within a single ADuM1510 component.

Propagation delay skew refers to the maximum amount that the propagation delay differs among multiple ADuM1510 components operated under the same conditions.

### DC CORRECTNESS AND MAGNETIC FIELD IMMUNITY

Positive and negative logic transitions at the isolator input cause narrow ( $\sim 1$  ns) pulses to be sent via the transformer to the decoder. The decoder is bistable and is, therefore, either set or reset by the pulses indicating input logic transitions. In the absence of logic transitions at the input for more than  $\sim 1$   $\mu\text{s}$ , a periodic set of refresh pulses indicative of the correct input state is sent to ensure dc correctness at the output.

If the decoder receives no pulses for more than approximately 5  $\mu\text{s}$ , the input side is assumed to be unpowered or nonfunctional, in which case, the isolator output is forced to a default low state by the watchdog timer circuit (see Table 8).

The limitation on the magnetic field immunity of the device is set by the condition in which induced voltage in the transformer receiving coil is sufficiently large to either falsely set or reset the decoder. The analysis below defines such conditions. In the following analysis, the ADuM1510 is examined in a 3 V operating condition because it represents the most susceptible mode of operation of all products in its product family.

The pulses at the transformer output have an amplitude greater than 1.0 V. The decoder has a sensing threshold of approximately 0.5 V, thus establishing a 0.5 V margin in which induced voltages can be tolerated. The voltage induced across the receiving coil is given by

$$V = (-d\beta/dt) \Sigma \pi r_n^2 ; n = 1, 2, \dots N$$

where:

$\beta$  is the magnetic flux density (gauss).

$r_n$  is the radius of the nth turn in the receiving coil (cm).

$N$  is the number of turns in the receiving coil.

Given the geometry of the receiving coil in the ADuM1510 and an imposed requirement that the induced voltage be at most 50% of the 0.5 V margin at the decoder, a maximum allowable magnetic field can be calculated, as shown in Figure 11.

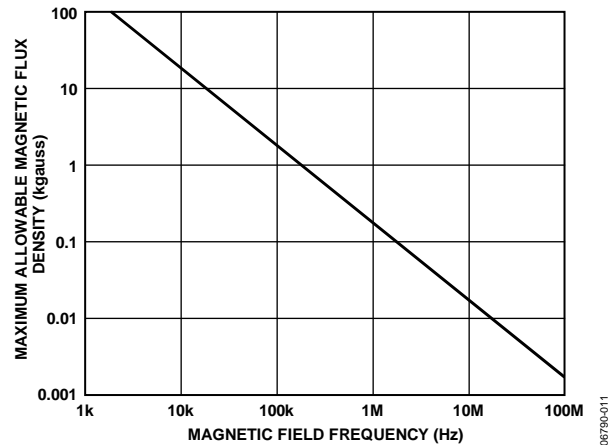

Figure 11. Maximum Allowable External Magnetic Flux Density

For example, at a magnetic field frequency of 1 MHz, the maximum allowable magnetic field of 0.2 kgauss induces a voltage of 0.25 V at the receiving coil. This voltage is approximately 50% of the sensing threshold and does not cause a faulty output transition. Similarly, if such an event occurs during a transmitted pulse (and is of the worst-case polarity), the received pulse is reduced from  $>1.0$  V to 0.75 V, still well above the 0.5 V sensing threshold of the decoder.



The preceding magnetic flux density values correspond to specific current magnitudes at given distances away from the ADuM1510 transformers. Figure 12 expresses these allowable current magnitudes as a function of frequency for selected distances. As seen in Figure 12, the ADuM1510 is extremely immune and is affected only by extremely large currents operated at high frequency and very close to the component. For example, at a magnetic field frequency of 1 MHz, a 0.5 kA current would need to be placed 5 mm away from the ADuM1510 to affect the operation of the component.

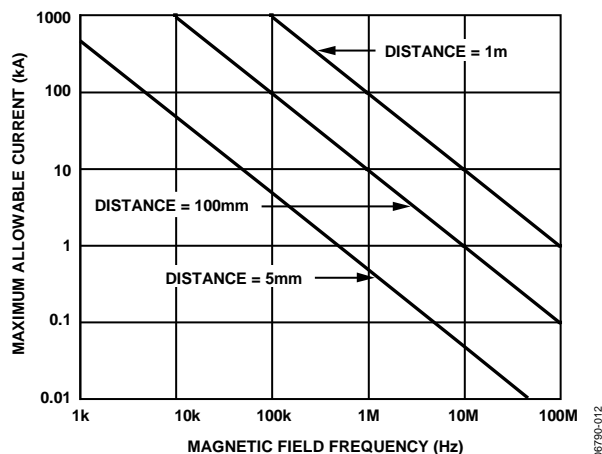

Figure 12. Maximum Allowable Current for Various Current- to-ADuM1510 Spacings

Note that at combinations of strong magnetic field and high frequency, any loops formed by PCB traces can induce sufficiently large error voltages to trigger the thresholds of succeeding circuitry. Care should be taken in the layout of such traces to avoid this possibility.

## POWER CONSUMPTION

The supply current at a given channel of the ADuM1510 isolator is a function of the supply voltage, the channel data rate, and the channel output load.

For each input channel, the supply current is given by

$$I_{DDI} = I_{DDI(Q)} \quad f \leq 0.5f_r$$

$$I_{DDI} = I_{DDI(D)} \times (2f - f_r) + I_{DDI(Q)} \quad f > 0.5f_r$$

For each output channel, the supply current is given by

$$I_{DDO} = I_{DDO(Q)} \quad f \leq 0.5f_r$$

$$I_{DDO} = (I_{DDO(D)} + C_L V_{DDO}) \times (2f - f_r) + I_{DDO(Q)} \quad f \leq 0.5f_r$$

where:

$I_{DDI(Q)}$ ,  $I_{DDO(Q)}$  are the specified input and output quiescent supply currents (mA).

$I_{DDI(D)}$ ,  $I_{DDO(D)}$  are the input and output dynamic supply currents per channel (mA/Mbps).

$C_L$  is the output load capacitance (pF).

$V_{DDO}$  is the output supply voltage (V).

$f$  is the input logic signal frequency (MHz, half of the input data rate, NRZ signaling).

$f_r$  is the input stage refresh rate (Mbps).

To calculate the total  $I_{DD1}$  and  $I_{DD2}$  supply current, the supply currents for each input and output channel corresponding to  $I_{DD1}$  and  $I_{DD2}$  are calculated and totaled. Figure 4 and Figure 5 provide per-channel supply currents as a function of the data rate for an unloaded output condition. Figure 6 provides per-channel supply current as a function of the data rate for a 15 pF output condition. Figure 7 and Figure 8 provide total  $I_{DD1}$  and  $I_{DD2}$  supply current as a function of the data rate for ADuM1510 products.

## POWER-UP/POWER-DOWN CONSIDERATIONS

Given that the ADuM1510 has separate supplies on each side of the isolation barrier, the power-up and power-down characteristics relative to each supply voltage need to be considered individually.

As shown in Table 8, when  $V_{DD1}$  input power is off, the ADuM1510 outputs take on a default low logic condition. As the  $V_{DD1}$  supply is increased or decreased, the output of each channel transitions from/to the default condition to/from the state matching its respective signals (see Figure 13 and Figure 14).

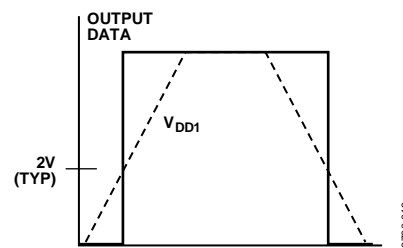

Figure 13.  $V_{DD1}$  Power-Up/Power-Down Characteristics, Input Data = High

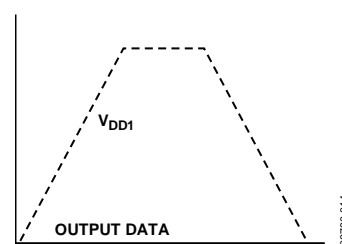

Figure 14.  $V_{DD1}$  Power-Up/Power-Down Characteristics, Input Data = Low

When  $V_{DD1}$  crosses the threshold for activating the refresh circuit (approximately 2 V), there can be a delay of up to 2  $\mu$ s before the output is updated to the correct state, depending on the timing of the next refresh pulse. When  $V_{DD1}$  is reduced from an on state below the 2 V threshold, there can be a delay of up to 5  $\mu$ s before the output takes on its default low state. This corresponds to the duration that the watchdog timer circuit at the input is designed to wait before triggering an output default state.

# ADuM1510

When the  $V_{DD2}$  output supply is below the level at which the ADuM1510 output transistors are biased (approximately 1 V), the outputs take on a high impedance state.

When  $V_{DD2}$  is above a value of approximately 2 V, each channel output takes on a state matching that of its respective input. Between the values of 1 V and 2 V, the outputs are set low. This behavior is shown in Figure 15 and Figure 16.

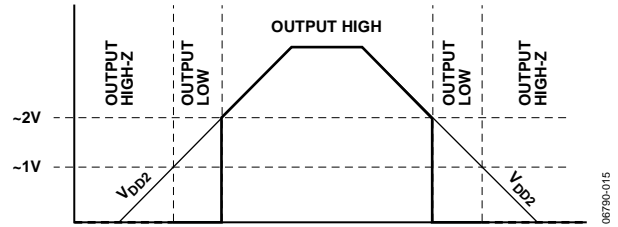

Figure 15.  $V_{DD2}$  Power-Up/Power-Down Characteristics, Input Data = High

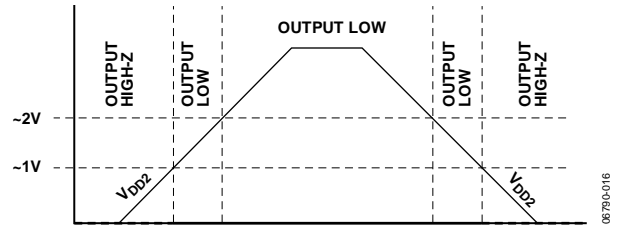
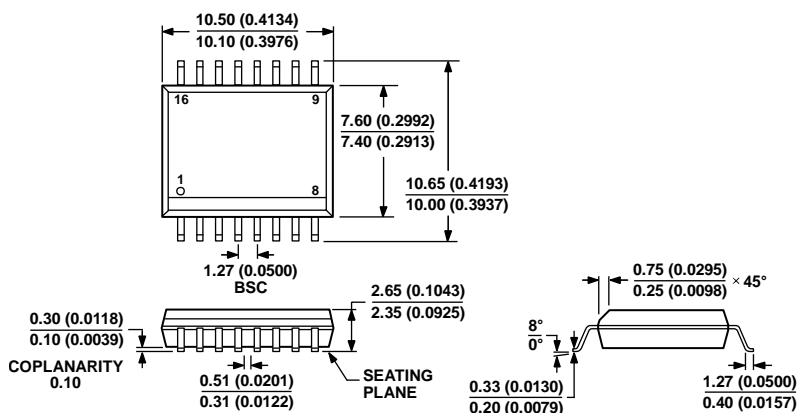

Figure 16.  $V_{DD2}$  Power-Up/Power-Down Characteristics, Input Data = Low

# OUTLINE DIMENSIONS



COMPLIANT TO JEDEC STANDARDS MS-013-AA  
 CONTROLLING DIMENSIONS ARE IN MILLIMETERS; INCH DIMENSIONS  
 (IN PARENTHESES) ARE ROUNDED-OFF MILLIMETER EQUIVALENTS FOR  
 REFERENCE ONLY AND ARE NOT APPROPRIATE FOR USE IN DESIGN.

032707-B

Figure 17. 16-Lead Standard Small Outline Package [SOIC\_W]  
 Wide Body (RW-16)  
 Dimensions shown in millimeters and (inches)

## ORDERING GUIDE

Model	Number of Inputs, V <sub>DD1</sub> Side	Number of Inputs, V <sub>DD2</sub> Side	Maximum Data Rate	Maximum Propagation Delay, 5 V	Maximum Pulse Width Distortion	Temperature Range	Package Description	Package Option
ADuM1510BRWZ <sup>1</sup>	5	0	10 Mbps	50 ns	5 ns	-40°C to +105°C	16-Lead SOIC_W	RW-16
ADuM1510BRWZ-RL <sup>1</sup>	5	0	10 Mbps	50 ns	5 ns	-40°C to +105°C	16-Lead SOIC_W, 13" Tape and Reel	RW-16

<sup>1</sup> Z = RoHS Compliant Part.

**ADuM1510**

**NOTES**